

Data Sheet



Article number: 20892001

Description: E+G Tool for GN 613
GN 613.1-5

Measures

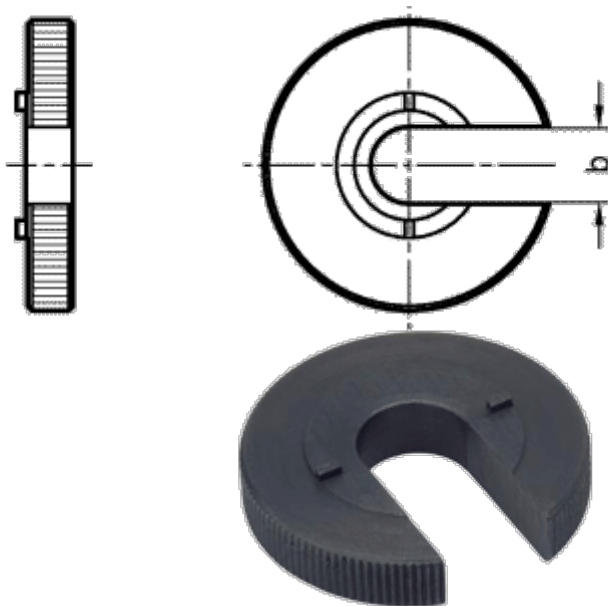

b = 5 mm